



## **Lighting up the evening atmosphere.**

The modular string light solution that transforms outdoor spaces with elegance and harmony.

**A unique atmosphere, a distinctive design.**

**MADINA**

# MARINA

Marina is more than just a string light — it's a blank canvas for your outdoor lighting ideas. Its light sources, connected by cables in sea-inspired colours — **starfish red, olive green, and sandy white** — create a refined, immersive ribbon of light. Ideal for gardens, terraces, poolside areas, or for setting the scene at unforgettable events and installations.



## IP67 DEGREE OF PROTECTION

Durable and safe, this product is designed to withstand the rigors of **outdoor environments**. It is **perfect for outdoor use**, offering reliable performance even in challenging conditions. Its resistance to wind, rain, dust and even temporary immersion in water, ensures that it remains protected and functional regardless of weather changes or exposure to the elements.

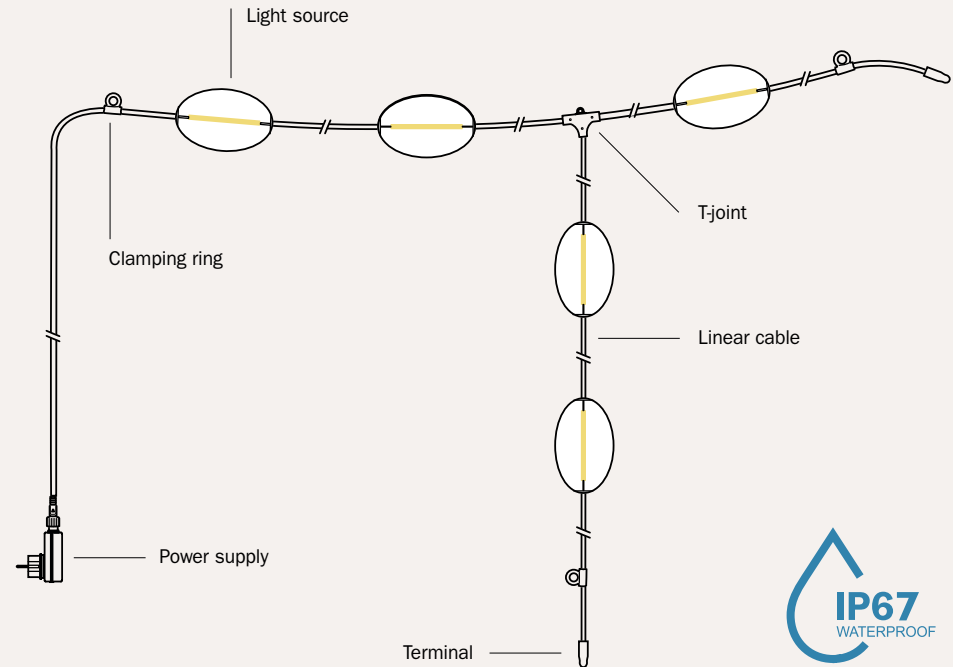



Inspired by floating buoys, Marina redefines outdoor spaces with luminous elements that serve as true architectural features. The **shatterproof shades** combine durability with elegance, making **Marina** an ideal choice — even for public installations.

## MARINA COMPONENTS

### Soft, diffused light

The 15 cm elliptical light sources deliver a soft, functional glow that is glare-free.

LIGHT SOURCE



### Easy to install

Rings at the ends and at strategic points make it easy to fix, for a perfectly balanced suspended light.

CLAMPING RING



### Modular system

Design your own lighting scheme by connecting up to 12 elements.

T-JOINT





## MARINA CONFIGURATIONS

Whether you're furnishing a terrace, a garden or a hospitality area, we can create bespoke versions up on request—tailored in length, layout and number of light points (upon a maximum of 12).

Available in linear layouts with **3, 6, or 12 light points**, or in **grid configurations with 7 light points**, Marina is fully **customisable on request** and designed to adapt to any setting.

ROUND PVC ELECTRICAL CABLES  
RESISTANT TO UV RAYS

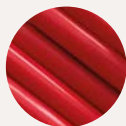

Starfish red

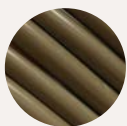

Olive green







Sandy white





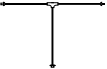

# CUSTOMISE YOUR STRING LIGHT

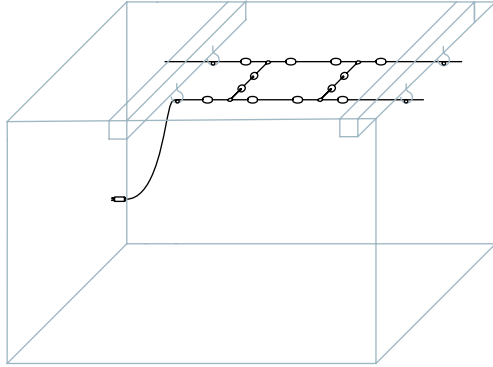

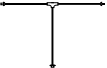

Every space deserves its own light. That's why **Marina** is designed to be modified, extended and adapted. Below are some examples of use cases.

-  x 1
-  x 12
-  x 1
-  x 4
-  x 4
-  x 3

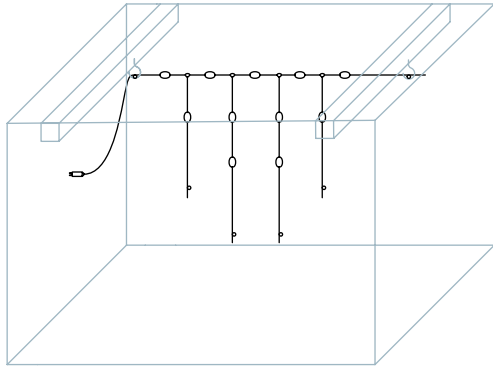



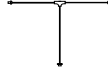

-  x 1
-  x 11
-  x 1
-  x 4
-  x 2
-  x 5

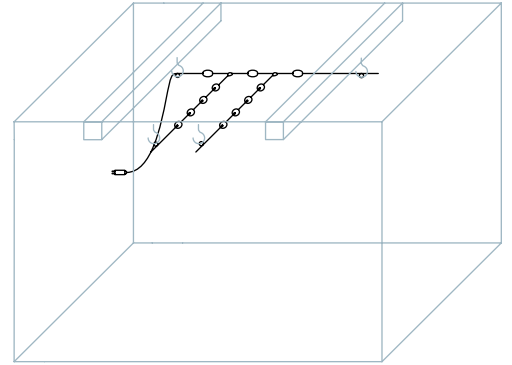

-  x 1
-  x 11
-  x 1
-  x 2
-  x 6
-  x 3

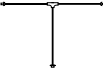

-  x 1
-  x 6
-  x 1
-  x 0
-  x 5
-  x 1

